



# BLU26 INTERNATIONAL CLASS RULES 2024

## INDEX

### INTRODUCTION

### PART I – ADMINISTRATION

#### **Section A – General**

- A.1 Language
- A.2 Abbreviations
- A.3 Authorities
- A.4 Administration of the Class
- A.5 World Sailing Rules
- A.6 Class Rules Variations
- A.7 Class Rules Amendments
- A.8 Class Rules Interpretation
- A.9 Spare
- A.10 Sail Numbers
- A.11 Hull Certification
- A.12 Initial Hull Certification
- A.13 Validity of Certificate
- A.14 Hull Re-Certification
- A.15 Retention of Certification Documentation

#### **Section B – Boat Eligibility**

- B.1 Class Rules and Certification
- B.2 Class Association Membership

## **PART II – REQUIREMENTS AND LIMITATIONS**

### **Section C – Conditions for Racing**

- C.1 General
- C.2 Crew
- C.3 Personal Equipment
- C.4 Advertising
- C.5 Portable Equipment
- C.6 Boat
- C.7 Hull
- C.8 Hull Appendages
- C.9 Rig
- C.10 Sails
- C.11 Boat Handling Rules

### **Section D– Hull**

- D.1 Parts
- D.2 General
- D.3 Hull Shell
- D.4 Deck
- D.5 Bulkheads & Internal
- D.6 Assembled Hull

### **Section E – Hull Appendages**

- E.1 Parts
- E.2 General
- E.3 Keel
- E.4 Rudder Blade, Rudder Stock and Tiller

### **Section F – Rig**

- F.1 Parts
- F.2 General
- F.3 Mast
- F.4 Boom
- F.5 Spinnaker Pole
- F.6 Standing Rigging
- F.7 Running Rigging

### **Section G – Sails**

- G.1 Parts
- G.2 General
- G.3 Mainsail
- G.4 Jib
- G.5 Genoa
- G.6 Masthead Spinnaker
- G.7 Fractional Spinnaker

## **PART III – APPENDICES**

### **Appendices A 1 to A 3, F1 and H 1 to H6**

Measurement diagrams and list of hardware and fittings

# INTRODUCTION

*The intention of these Blu26 International Class rules is to ensure the boats are as identical as possible in construction, hull shape, weight, weight distribution, equipment, rigging and sail plan. Therefore, coring, drilling out, rebuilding, replacement of material, grinding or relocating standard equipment, fairing interior or exterior parts of **hull, hull appendages** or **rig** that improves moments of inertia, or changes the standard shapes or contours shall be prohibited.*

*Blu26 hulls, hull appendages, rigs and sails (if manufactured by an World Sailing certified sail loft recognised in the country where the yacht is registered) are measurement and manufacture controlled.*

*Blu26 hulls and rigs shall only be manufactured by a from Bluboats GmbH appointed subcontractor. Bluboats GmbH is in the class rules referred to as the licensed builder.*

*Blu26 sails may be manufactured by optional sailmakers.*

*Equipment is required to comply with the Blu26 Building Specifications.*

*Blu26 hulls, hull appendages, rigs and sails may, after having left the manufacturer, only be altered to the extent permitted in section C of the class rules.*

*Owners and crews should be aware that compliance with rules in section C is NOT checked as part of the certification process.*

*Rules regulating the use of equipment during a race are contained in Section C of these class rules, in ERS Part I and in the Racing Rules of Sailing.*

*This introduction only provides an informal background and the Blu26 International Class Rules proper begin on the next page.*

*The rules in Part II and III are **closed class rules**.*

**PLEASE REMEMBER:  
IF THESE RULES DO NOT SAY YOU CAN,  
THEN YOU CANNOT!**

# PART I – ADMINISTRATION

## Section A – General

### A.1 LANGUAGE

- A.1.1 The official language of the class is English and in case of dispute over translation the English text shall prevail.
- A.1.2 The word “shall” is mandatory and the word “may” is permissive.

### A.2 ABBREVIATIONS

- WS World Sailing
- MNA World Sailing Member National Authority
- BICA Blu26 International Class Association
- NCA National Class Association
- ERS Equipment Rules of Sailing
- RRS Racing Rules of Sailing
- TC Technical Committee of the International Blu26 Class Association
- CM Class Chief Measurer
- MF Measurement Form
- MC Measurement Certificate

### A.3 AUTHORITIES

- A.3.1 The international authority of the class is the BICA Blu26 International Class Association
- A.3.2 Notwithstanding anything contained herein, the **certification authority** has the authority to withdraw a **certificate**. As long as the class is not accepted as an official class by the MNA it's the Class organisation is the certification authority.
- A.3.3 The **Copyright Holder** is:  
Bluboats GmbH, Kellermattstrasse 1, CH-6044 Udligenswil.

### A.4 ADMINISTRATION OF THE CLASS

- A.4.1 World Sailing has delegated its administrative functions of the Class to MNAs. The MNA may delegate part or all of its functions, as stated in these **class rules**, to an NCA.
- A.4.2 In countries where there is no MNA, or the MNA does not wish to administrate the class, its functions as stated in these **class rules** shall be carried out by the BICA which may delegate the administration to an NCA.
- A.4.3 Neither BICA, nor NCA, the copyright holder or an official measurer is under any legal responsibility in respect of these class rules.
- A.4.4 A measurer shall seek approval from the BICA, but shall only be an official measurer when recognised or appointed by a MNA.
- A.4.5 The CM has excess to the confidential Blu26 building specifications.

### A.5 WOLRD SAILING RULES

- A.5.1 These **class rules** shall be read in conjunction with the ERS.
- A.5.2 Except where used in headings, when a term is printed in “**bold**” the definition in the ERS applies and when a term is printed in “*italics*” the definition in the RRS applies.

## **A.6 CLASS RULES VARIATIONS**

A.6.1 At class events – see RRS 89.1.d) – World Sailing Regulation 26.5(f) applies. At all other events RRS 87 applies.

## **A.7 CLASS RULES AMENDMENTS**

A.7.1 Amendments to these **class rules** are subject to the approval of the BICA Blu26 International Class Association and shall be voted upon on the annual or an exceptional meeting.

## **A.8 CLASS RULES INTERPRETATION**

A.8.1 Interpretation of **class rules** shall be made by the Class Chief Measurer upon consultation of the TC in accordance with the World Sailing regulations.

## **A.9 SPARE**

## **A.10 SAIL NUMBERS**

A.10.1 Sail numbers are given by the number on the International Class Building Plaque.

## **A.11 HULL CERTIFICATION**

A.11.1 A **Certificate** shall record the following information:

- (a) Class
- (b) **Certification authority**
- (c) Sail number
- (d) Owner
- (e) Craft identification number (Hull nb. and mould nb.)
- (f) Builder/Manufacturers details/ Building date
- (g) Date of issue of initial **certificate**
- (h) Date of issue of **certificate**
- (i) Keel weight
- (j) Keel serial number
- (k) Complete boat weight
- (l) Corrector weights

## **A.12 INITIAL HULL CERTIFICATION**

A.12.1 For a **certificate** to be issued to hull not previously **certified**:

- (a) **Certification control** shall be carried out by an **official measurer** who shall complete the appropriate documentation.
- (b) The documentation and **certification** fee, if required, shall be sent to the **certification authority**.
- (c) Upon receipt of a satisfactorily completed documentation and **certification** fee, if required, the **certification authority** may issue a **certificate**.

## **A.13 VALIDITY OF CERTIFICATE**

A.13.1 A hull **certificate** becomes invalid upon:

- (a) the change to any items recorded on the hull **certificate** as required under A.11.
- (b) withdrawal by the **certification authority**,
- (c) the issue of a new **certificate**.

## **A.14 HULL RE-CERTIFICATION**

A.14.1 The **certification authority** may issue a **certificate** to a previously certified **hull**:

- (a) when it is invalidated under A.13.1(a) and/or after receipt of the old **certificate**, and **certification** fee if required.
- (b) when it is invalidated under A.13.1 (b), at its discretion.
- (c) in other cases, by application of the procedure in A.12.

## **A.15 RETENTION OF CERTIFICATION DOCUMENTATION**

A.15.1 The **certification authority** shall:

- (a) retain a copy of the measurement form (MF) upon which the current **certificate** is based.
- (b) upon request, transfer this documentation to the new **certification authority** if the hull is exported.

# **Section B – Boat Eligibility**

For a **boat** to be eligible for *racing*, it shall comply with the rules in this section.

## **B.1 CLASS RULES AND CERTIFICATION**

B.1.1 The boat shall:

- (a) be in compliance with the **class rules**.
- (b) have a valid measurement certificate.
- (c) have valid **certification marks** as required. The International Class building plaque shall be permanently displayed on the keel tower inside the yacht.

## **B.2 CLASS ASSOCIATION MEMBERSHIP**

B.2.1 The owner and helmsman shall be a current member of their NCA or, where there is no NCA in his country, a member of the BICA or and NCA nominated by the BICA.

B.2.2 Sail have to carry at least the date of measurement, the name of the measurer (print) and the signature of the measurer.

# PART II – REQUIREMENTS AND LIMITATIONS

The **crew** and the **boat** shall comply with the rules in Part II when *racing*. In case of conflict Section C shall prevail.

The rules in Part II are **closed class rules**. **Certification control** and **equipment inspection** shall be carried out in accordance with the ERS except where varied in this Part.

## Section C – Conditions for Racing

### C.1 GENERAL

#### C.1.1 RULES

- (a) The current RRS shall apply
- (b) RRS 42.3(c) is modified to allow the spinnaker sheet to be played without restriction.
- (c) The ERS Part I – Use of Equipment shall apply.

### C.2 CREW

#### C.2.1 LIMITATIONS

- (a) The **crew** shall consist of a maximum of 5 persons.
- (b) No **crew** member shall be substituted during an event of less than 7 consecutive days, unless prior written permission has been granted by the race committee or Jury.

#### C.2.2 WEIGHTS

Maximum weight: The total weight of the **crew** dressed in underwear shall not be more than 350 kg.

Crews shall be weighed during the registration period prior to racing.

### C.3 PERSONAL EQUIPMENT

#### C.3.1 MANDATORY

- (a) The boat shall be equipped with **personal buoyancy** for each crew member to the minimum standard EN 393: 1995 (CE 50 Newtons), or USCG Type III, or AUS PFD 1.

### C.4 ADVERTISING

#### C.4.1 LIMITATIONS

Advertising shall only be displayed in accordance with the World Sailing Advertising Code except as modified here. It shall apply to all Blu26 Class racing.

C.4.2 The number of advertisers is unrestricted.

C.4.3 The following restrictions on advertising shall apply:

#### HULL:

- (a) The area 1m long, aft of the bow shall be kept free for event advertising.
- (b) The remaining area may carry advertising chosen by the boat to a total maximum length of 3m.
- (c) The cockpit may carry advertising chosen by the boat and is unrestricted in length.

- (d) The deck may carry advertising chosen by the boat and can be of unrestricted area. The advert may connect to the advert on the hull side.

**HULL APPENDAGES:**

Advertising chosen by the boat may be displayed on the keel fin and bulb, rudder and tiller. The area is unrestricted, and each item may display a different advertiser.

**MAST:**

Advertising chosen by the boat may be displayed on the mast. The maximum length of the adverts shall be 3.2m. Different advertisers may be on each side of the mast.

**BOOM:**

Advertising chosen by the boat may be displayed on the boom. The length is unrestricted. Different advertisers may be on each side of the boom.

**SAILS:**

SPINNAKER: Unrestricted.

HEADSAIL: Unrestricted.

MAINSAIL: At all times the advertising shall be below and clearly separated from the class logo, national letters and sail numbers. Apart these restrictions, the size is unrestricted.

**C.5 PORTABLE EQUIPMENT**

**C.5.1 FOR USE**

(a) **MANDATORY**

- (1) One bucket or bailer and a sponge.
- (2) One anchor of not less than 8 kg.
- (3) One anchor line, diameter 8 mm and of not less than 20 m
- (4) Two main companionway hatches.

(b) **OPTIONAL**

- (1) Electronic or mechanic timing devices
- (2) Navigation lights, tactical and navigational instruments and their associated power sources.
- (3) Mooring lines
- (4) Cool/ice box
- (5) Bunk cushions and their support boards
- (6) Protective bag for companionway hatches
- (7) One outboard engine not for use

**C.6 BOAT**

**C.6.1 WEIGHT**

The weight of the **boat** in dry conditions, including **corrector weights**, spars/spinnaker pole, lifting slings, two main companionway hatches, all running rigging including and one set of sheets for spinnaker, jib and mainsail, two winch handles and the tiller extension shall not be less than 1250 kg.



The weight shall be taken excluding **sails** - engine, bracket and fuel can - anchor and warp - bucket and lanyard - and all portable equipment as listed in C.5.1(b) except that the permanently fixed parts of timing and navigational/tactical equipment (e.g. display heads and sensors) may be include in the weight. All batteries and power sources shall be removed.

C.6.2 CORRECTOR WEIGHTS (see drawing Appendix A3)

- (a) **Corrector weights** of lead shall be equally divided port and starboard, centred and permanently placed in the locations in the buoyancy tank adjoining to the keel structure if the **boat** weight is less than the minimum requirement.
- (b) The total weight of such **corrector weights** shall not exceed 75 kg. See also rules A.13 and B.1.1.
- (c) Corrector weights may only be altered after a full certification control.

**C.7 HULL**

C.7.1 MODIFICATIONS, MAINTENANCE AND REPAIR

- (a) The moulded gel coat below the waterline and for not more than 30mm above the waterline may be lightly abraded back to allow for the application and adhesion of anti-fouling products, for those boats to be left afloat. The abrasion of the gel coat shall be the minimum needed to ensure adhesion of the coating and shall not involve fairing of any sort.
- (b) Normal propriety polishes may be used on the hull if in compliance with RRS 53.
- (c) Sanding is prohibited on all hull, deck and internal structures unless repair of superficial damage is required. If there is any doubt to the interpretation of "superficial damage", a ruling shall be sought from the Chief Measurer or the Technical Committee before repair work commences and the boat offered for re-measurement on completion.
- (d) If the hull requires to be painted to repair a damaged gelcoat, the process shall be reported to a measurer and the boat offered for **re-certification** on completion

C.7.2 FITTINGS

- (a) The deck hardware and winches fitted on every boat as standard is detailed in Appendix F1. The equipment shall be maintained and serviced according to the suppliers specifications.
  - (1) Adjustable jib cars are permitted.
  - (2) The manufacturer or brand of the blocks and winches is given by the manufacturer. Their height and position may not be changed.
  - (3) The position of the winches or deck ratchet blocks for the spinnaker and jib and their associated cleats may not be changed. There shall be not more than two cleats per side for the jib.
  - (4) The spinnaker turning blocks are to be free running and not to be ratcheted.
  - (5) The mainsheet swivel cleat may be fitted either forward or aft of the mainsheet track.
  - (6) There shall be no hiking line.
  - (7) No additional foot chocks may be fitted to the cockpit floor.
  - (8) Fairings of any material may be used over blocks and fittings on deck to assist in the free running of sheets and control lines.

- (9) Storage bags may be attached to the cockpit moulding.
- (10) Protective covers may cover the shrouds, vang and recess for the furler drum.
- (11) Non slip tape or similar non slip material may be added to the decks, cockpit floor and gunwale edge as necessary.

## C.8 HULL APPENDAGES

### C.8.1 MODIFICATIONS, MAINTENANCE AND REPAIR

- (a) Normal propriety polishes may be used on the **hull appendages** if in compliance with RRS 53.

### C.8.2 KEEL (see drawing in Appendix A1)

- (a) DIMENSIONS [mm], keel fully lowered:

	minimum	maximum
<b>Hull datum point</b> to intersection of hull and fin trailing edge, around hull on centreline	4110	4130
<b>Hull datum point</b> to intersection of fin trailing edge and top of keel bulb in straight line	4420	4460
Underside of hull in a straight line to top of keel bulb at the trailing edge of the keel	1365	1385

- (b) USE

- (1) The **keel** shall be fixed down using the supplied bolts, washers and keel chocks.
- (2) The **keel** shall only be retracted when not racing, using the BLU26 designed lifting crane.

### C.8.3 RUDDER (see drawing in Appendix A2)

- (a) DIMENSIONS [mm]

	minimum	maximum
<b>Hull datum point</b> to trailing edge of rudder top around hull on centreline	440	460
Shortest distance between the upper edge and the lowest point of the rudder	1405	1415
<b>Hull datum point</b> to rudder bottom tip of training edge in straight line	1490	1520

Washers of maximum 5mm may be fitted between the rudder and tiller to ensure a good fit.

## C.9 RIG

### C.9.1 MODIFICATIONS, MAINTENANCE AND REPAIR

- (a) Routine maintenance such as cleaning, polishing, repair of minor abrasions and the replacement of fittings is permitted without re-measurement and re-**certification**.

#### C.9.2 LIMITATIONS

- (a) Only one set of **spars** and standing **rigging** shall be used during an event of less than 7 consecutive days, except when an item has been lost or damaged beyond repair.

#### C.9.3 MAST

- (a) USE
  - (1) The spreaders shall not be modified or changed during a regatta.
  - (2) The mast as supplied and assembled in accordance with the building specifications shall be stepped on the standard mast step. No wedges or similar devices shall be used to control or alter the rake or the bending characteristics of the rig, except that permanently attached shims may be used to correct misalignment.

#### C.9.4 BOOM

- (a) USE
  - (1) The intersection of the aft edge of the mast **spar** and the top of the boom **spar**, each extended as necessary, shall not be below the upper edge of the mast **lower limit mark** when the boom **spar** is at 90° to the mast **spar**.
  - (3) The boom may be fitted with carrying device to store the spinnaker pole. The bottom of this carrying device shall not exceed 50 mm below the bottom of the boom **spar**.

#### C.9.5 STANDING RIGGING

- (a) USE
  - (1) The shrouds and forestay may be attached and adjusted by turnbuckles/bottle screws/pin plates of optional design. Lock plates may be fitted.
  - (2) Rigging links and rigging screws may be adjusted between races, but at the turnbuckles/bottle screws only. Remote adjustment of any type is prohibited.

#### C.9.6 RUNNING RIGGING

- (a) USE
  - (1) The main halyard shall be secured in the mounted sheet stopper.
  - (2) The jib halyard shall be secured in the mounted sheet stopper.
  - (3) The spinnaker halyard shall be secured in the mounted sheet stopper.
  - (4) The complete boom vang shall have a maximum purchase of 1:8.
  - (5) No lines shall lead below deck other than the jib furling line, the barber lines and the gennaker down hole – not in use.
  - (6) Additions to or subtractions of purchase, spinnaker sheet system, main cunningham, main outhaul, traveller controls, backstay or reefing systems shall not be permitted.

## C.10 SAILS

### C.10.1 MODIFICATIONS, MAINTENANCE AND REPAIR

- (a) **Sails** shall not be altered in any way except as permitted by these **class rules**.
- (b) Routine maintenance such as cleaning and minor repairs is permitted without re-measurement and re-**certification**.

### C.10.2 LIMITATIONS

- (a) Not more than 1 mainsail, 2 headsails and 2 spinnaker shall be carried aboard.
- (b) Not more than 1 mainsail, 2 headsails and 2 spinnaker shall be presented for registration and used during an event of less than 7 consecutive days, except when a **sail** has been damaged beyond repair.

### C.10.3 MAINSAIL

- (a) **USE**
  - (1) The **sail** shall be hoisted on a halyard. The arrangement shall permit hoisting and lowering of the **sail** at sea.
  - (2) The highest visible point of the **sail**, projected at 90° to the mast **spar**, shall not be set above the lower edge of the mast **upper limit mark**. The intersection of the **leech** and the top of the boom **spar**, each extended as necessary, shall not be behind the fore side of the boom **outer limit mark**.
  - (3) The **luff** bolt rope shall be in the **spar** groove.
  - (4) The mainsail shall be loose-footed.

### C.10.4 HEADSAILS

- (a) **USE**
  - (1) The jib may be capable of being furled around the forestay, from the cockpit, using the designed furling system.
  - (2) The genoa may be capable of being furled around the forestay, from the cockpit, using the designed furling system.

### C.10.5 SPINNAKERS

- (a) **IDENTIFICATION**

The sail numbers and national letters are optional.
- (b) **USE**
  - (1) The spinnakers may be stowed in the front hatch or in the companionway hatch.
  - (2) The masthead spinnaker shall be fitted with the spinnaker halyard on the top mast and for the fractional spinnaker on thru the feeder above the forestay fitting see drawing Appending H1.

## C.11 BOAT HANDLING RULES

C.11.2. Cross sheeting is prohibited.

C.11.3. Sheeting the jib / genoa sheet on the cabin roof winches is prohibited.

## Section D – Hull

### D.1 PARTS

#### D.1.1 MANDATORY

- (a) Hull shell
- (b) Deck
- (c) Internal mouldings and bulkheads
- (d) Engine stowage tray
- (e) Mast compression post

### D.2 GENERAL

#### D.2.1 RULES

- (a) The **hull** shall comply with the **class rules** in force at the time of initial **certification**.

#### D.2.2 CERTIFICATION (See Rule A.11.)

The Chief Measurer (**CM**), the Technical Committee of the BICA, or World Sailing may use core sampling test to determine compliance with construction rules.

#### D.2.3 MODIFICATIONS, MAINTENANCE AND REPAIR

- (a) The hull shell, deck, bulkheads, and cockpit shall not be altered in any way except as permitted by these **class rules**.
- (b) Holes not bigger than necessary for the installation of through core speed meters and depth sounders may be made in the hull shell.
- (c) Routine maintenance such as painting and polishing and minor repairs is permitted without re-measurement and re-**certification**.
- (d) If any hull moulding is substantially altered or repaired in any other way than described in D.2.3(c), its measurement Certificate shall cease to be valid until the relevant parts of the hull have been re-measured and the measurement **certificate** re-validated by the MNA.

#### D.2.4 DEFINITIONS

##### (a) HULL DATUM POINT

The **hull datum point** is the intersection of the **hull** rocker and the transom plane at the centreline.

#### D.2.5 IDENTIFICATION

- (a) The hull shall carry the World Sailing Plaque permanently placed on the keel tower.
- (b) All boats shall carry an official serial number which shall include the sail number, moulded into a securely fixed position. This number shall be either; part of a national requirement such as European Standard ISO 10087 (1996) for those relevant countries, or, where the builder does not have to conform to a national requirement, or does not intend for his boats to be imported into Europe, the number shall be from a series formulated by Bluboats GmbH.

#### D.2.6 BUILDERS

- (a) The hull shall be built by a builder licensed by the copyright holder.
- (b) All moulds shall be approved by the copyright holder.

- (c) The licensed builder shall, at his own expense, correct or replace any hull that does not comply with the class rules as a result of an omission or error by the builder, if the hull is submitted for fundamental measurement within twelve months of purchase.

#### **D.2.7 LOGO AND LABELS**

- (a) The blu26 logo (writing) as specified in section H with a height of 80 mm shall be placed on the side of the cabin with a distance of 40 mm to the back edge.
- (b) The bluboats.com logo as specified in section H with a height of 50 mm shall be placed on the inside of the cockpit with a distance 220 mm to the transom.

### **D.3 HULL SHELL**

#### **D.3.1 MATERIALS**

- (a) The hull shell shall be built from glass reinforced materials specified within the Blu26 building specifications.

#### **D.3.2 CONSTRUCTION**

- (a) The hull shell shall be built from approved moulds in accordance with the Blu26 building specifications.

### **D.4 DECK**

#### **D.4.1 MATERIALS**

- (a) The deck shall be built from glass reinforced materials specified within the builder's license.

#### **D.4.2 CONSTRUCTION**

- (a) The deck shall be built from approved moulds in accordance with the building specifications.

#### **D.4.3 ALTERATIONS**

- (a) Teak deck or Esthec applications, either full or cockpit only, can be applied in accordance with the building specifications.

### **D.5 BULKHEADS AND INTERNAL MOULDINGS**

#### **D.5.1 MATERIALS**

- (a) The bulkheads and internal structures shall be built from glass reinforced materials specified within the builder's license.

#### **D.5.2 CONSTRUCTION**

- (a) The bulkheads and internal structures shall be built from approved moulds in accordance with the building specifications.

## **D.6 ASSEMBLED HULL**

### **D.6.1 FITTINGS**

#### **(a) MANDATORY**

Fittings shall be positioned in accordance with the building specifications and not modified unless stated within these rules:

- (1) Jib furling drum and forestay attachment.
- (2) Shroud plates.
- (3) Headsail tracks. The centreline of the tracks shall lie alongside the cabin sides on the level deck in the centre of the non-slip moulding. There shall be one track to port and one to starboard.
- (4) Mainsheet track with one traveller.
- (5) Aft spinnaker turning block deck plates
- (6) Bow pulpit as per building specifications

## **Section E – Hull Appendages**

### **E.1 PARTS**

#### **E.1.1 MANDATORY**

- (a) **Keel**
- (b) **Rudder**

### **E.2 GENERAL**

#### **E.2.1 RULES**

- (a) **Hull appendages** shall comply with the **Class Rules** in force at the time of the initial **certification**.

#### **E.2.2 MODIFICATIONS, MAINTENANCE AND REPAIR**

- (a) Hull appendages shall not be altered in any way except as permitted by these class rules.
- (b) Routine maintenance such as cleaning, polishing and the repair of superficial damage and abrasions is permitted without re-measurement and re-certification. If there is doubt of the interpretation of “superficial damage” a ruling shall be sought from the CM or the TC before starting the work. On completion the **appendage** shall be **re-certified**.

#### **E.2.3 CERTIFICATION**

- (a) The **official measurer** shall **certify hull appendages**.
- (b) An MNA may appoint one or more persons at a manufacturer to measure and **certify hull appendages** produced by that manufacturer in accordance with the World Sailing In-house Certification Guidelines.

#### **E.2.4 MANUFACTURERS**

- (a) The **hull appendages** shall be made by manufacturers licensed by the copyright holder.
- (b) The manufacturer shall, at his own expenses, correct or replace any **hull appendage** that does not comply with the class rules as a result of an omission or error by the builder.

### **E.3 KEEL**

#### **E.3.1 RULES**

- (a) The keel fin and keel bulb shall at no time be transferred from one hull to another without full re-**certification** to current class rules.

#### **E.3.2 MATERIALS**

- (a) The structure of the **keel** fin shall be of stainless steel (316) specified in the building specifications.  
(b) The **keel** bulb shall be of lead.  
(c) The **keel** bulb shall be covered as per the building specifications by the moulded shell.

#### **E.3.3 CONSTRUCTION + DIMENSIONS**

- (a) The **keel** shall be manufactured from a moulds approved by the copyright holder.

#### **E.3.4 FITTINGS**

##### **(a) MANDATORY**

- (1) The keel fin shall be fitted with a removable stainless steel ring used to lift the keel with the BLU26 keel crane.

#### **E.3.5 WEIGHT [kg]**

	minimum	maximum
Combined keel fin and keel bulb	590	610

### **E.4 RUDDER BLADE, RUDDER STOCK AND TILLER**

#### **E.4.1 RULES**

#### **E.4.2 MATERIALS**

- (a) The **rudder** blade shall be of glass fibre reinforced materials and high density foam core specified in the building specifications.  
(b) The tiller shall be of stainless steel 316. The tiller shall be manufactured to the design specified in the building specifications.  
(c) The tiller extension material is optional. The tiller extension shall be a maximum off 1100 mm.

#### **E.4.3 CONSTRUCTION + DIMENSIONS**

- (a) The **rudder** blade shall be manufactured in a mould approved by the copyright holder.



## Section F – Rig

### F.1 PARTS

#### F.1.1 MANDATORY

- (a) **Mast**
- (b) **Boom**
- (c) Standing **rigging**
- (d) Running **rigging**
- (e) Spinnaker **pole**

### F.2 GENERAL

#### F.2.1 RULES

- (a) The **spars** and their fittings shall comply with the **class rules** in force at the time of **Certification** of the **spar**.
- (b) The standing and running **rigging** shall comply with the **class rules**.

#### F.2.2 MODIFICATIONS, MAINTENANCE AND REPAIR

- (a) **Spars** shall not be altered in any way except as permitted by these **class rules**.
- (b) Routine maintenance such as cleaning, polishing, repair of minor abrasions and the replacement of fittings is permitted without re-measurement and re-**Certification**.

#### F.2.3 CERTIFICATION

- (a) The **official measurer** shall **certify spars**.
- (b) No **Certification** of standing and running **rigging** is required.
- (c) An MNA may appoint one or more persons at the **spar** builders to measure and **certify spars** produced by that manufacturer in accordance with the World Sailing In-house Certification Guidelines.

#### F.2.4 DEFINITIONS

- (a) **MAST DATUM POINT**  
The **mast datum point** is the top face of the bottom end of the mast spar (see Appendix H1).

#### F.2.5 MANUFACTURER

- (a) The **spar** builder shall be licensed by the Copyright holder.
- (b) The manufacturer shall, at his own expense, correct or replace any spar that does not comply with the class rules as a result of an omission or error by the builder.
- (c) The manufacturer of standing and running rigging is optional.

### F.3 MAST

#### F.3.1 MATERIALS

- (a) The **spar** shall be of aluminium alloy as specified within the builders specifications.

#### F.3.2 CONSTRUCTION

- (a) The **spar** extrusion shall be approved by the copyright holder and to the approved building specifications.

- (b) The **spar** shall be fitted out to the requirements of the building specifications.

### F.3.3 FITTINGS

- (a) The following are permitted:
- 1) mast head crane,
  - 2) backstay batten of 1200mm overall length,
  - 3) sheaves and sheave boxes,
  - 4) tangs and T ball sockets,
  - 5) two pair of spreaders,
  - 6) spreader attachments,
  - 7) gooseneck,
  - 8) boom vang fitting,
  - 9) supplied mast foot,
  - 10) compass bracket,
  - 11) protective cloth sleeves and items as permitted or prescribed by other applicable *rules*.
- (b) Spreader, including the spreader bar, to the approved design shall only be supplied by the licensed builder. The spreaders shall be connected with the spreader bar only.
- (c) The mast head crane shall be fitted with a sail batten connected to the backstay. The length and specifications of the batten is 1200 mm.

### F.3.4 DIMENSIONS [mm]

#### **Mast Datum Point see F.2.4**

	minimum	maximum
<b>Mast foot</b>	25	35
<b>Bottom of taper</b>	9560	
<b>Mast spar cross section</b> between MDP and bottom of taper		
<b>Fore-and-aft</b>	120	135
<b>Transverse</b>	80	85
<b>Mast limit mark width</b>	15	
<b>Lower point from MDP</b>		860
<b>Upper point from MDP</b>		10'510

Further mast dimensions according Appendix H1.

### F.3.5 WEIGHTS [kg]

The assembled mast with all normal hardware, running and standing rigging including turnbuckles and pins in place including navigation lights and cables, instrument brackets below the lower point when permanently fastened in dry condition shall have

	minimum
<b>Mast weight</b>	46 kg
<b>Mast tip weight</b> (as defined in ERS)	17 kg

A lead corrector weight of maximum 2.5 kg to reach **the tip weight** may be added at any location on the mast above the **upper limit mark** provided that it is permanently fastened.

An additional lead corrector weight to reach the minimum mast weight shall be added at the height of the **lower point**, provided that it is permanently fastened.

## F.4 BOOM

### F.4.1 MATERIALS

- (a) The **spar** shall be of aluminium alloy.
- (b) Permitted surface finish shall be anodised or spray or powder coated.

### F.4.2 CONSTRUCTION

- (a) The **spar** extrusion shall be approved by the builder.
- (b) The **spar** shall be built and fitted out to the requirements of the building specifications

### F.4.3 DIMENSIONS [mm]

	minimum	maximum
<b>Outer point distance</b>		3'440
<b>Boom spar cross section; Up-and-down</b>	100	125
<b>Transverse</b>	70	80
<b>Boom limit mark width</b>	15	

Other boom dimensions according Appendix H2.

### F.4.4 FITTINGS

- (a) The following are permitted:
  - 1) Clew outhaul and fittings,
  - 2) sheaves and sheave boxes,
  - 3) blocks,
  - 4) cleats,
  - 5) hooks,
  - 6) attachment fittings,
  - 7) spinnaker pole stowage fittings,
  - 8) reefing fittings and items as permitted or prescribed by other applicable *rules*.

## F.5 SPINNAKER POLE

### F.5.1 MATERIALS

- (a) The **spar** shall be of aluminium alloy.
- (b) Permitted surface finish shall be anodised or spray painted.

### F.5.2 CONSTRUCTION

- (a) The **spar** extrusion shall be approved by the builder.
- (b) The **spar** shall be built and fitted out to the requirements of the building specifications.

### F.5.3 DIMENSIONS [mm]

	minimum	maximum
<b>Spinnaker pole length</b>		3480
<b>Spinnaker pole diameter</b>	55	65

Pole dimensions according Appendix H2.

## **F.6 STANDING RIGGING**

### **F.6.1 MATERIALS**

- (a) The standing **rigging** shall be of stainless steel cable type Dyform 1x19.
- (b) The backstay material is optional.

### **F.6.2 FITTINGS**

- (a) The following are permitted:
  - 1) Turn buckles / bottle screws,
  - 2) pin plates,
  - 3) tangs,
  - 4) swages,
  - 5) swage eyes,
  - 6) shackles,
  - 7) shroud lock plates.

### **F.6.3 DIMENSIONS**

Forestay diameter	minimum 5.0 mm
V1, D1	5.0 mm
V2, D2, V3	4.0 mm
Backstay breaking load if not s/s wire	min 950 kg
The purchase system of the backstay is 1:12	

## **F.7 RUNNING RIGGING**

### **F.7.1 MATERIALS**

- (a) Materials are optional for the main and spinnaker halyards and for the jib halyard.
- (b) The material and diameter for sheets and control lines is optional unless specified.

### **F.7.2 CONSTRUCTION**

- (a) **MANDATORY**
  - 1) One Reef line
  - 2) Mainsail sheet
  - 3) Headsail halyard
  - 4) Headsail sheets
  - 5) Spinnaker halyard
  - 6) Spinnaker sheets
  - 7) Backstay control system
  - 8) Mainsail Cunningham line
  - 9) Mainsail outhaul system in the boom
  - 10) Mainsheet traveller control system
  - 11) Toppinglift
  - 12) Spinnaker pole downhaul
- (b) **OPTIONAL**
  - 1) Headsail furling line
  - 2) Asymmetric Spinnaker tack line

- F.7.3 FITTINGS  
(a) MANDATORY  
1) Boom Vang

## Section G – Sails (see Appendix H 4)

### G.1 PARTS

#### G.1.1 MANDATORY

- (a) Mainsail
- (b) Jib

#### G.1.2 OPTIONAL

- (a) Genoa
- (b) Masthead Spinnaker
- (c) Fractional Spinnaker

### G.2 GENERAL

*Where no limit(s) for a particular dimension is given then the item is not controlled and need not be measured.*

#### G.2.1 RULES

- (a) **Sails** shall comply with the **class rules** in force at the time of **certification**.

#### G.2.2 CERTIFICATION

- (a) The **official measurer** shall **certify** mainsails and headsails near the **tack** and spinnakers in the **head** and shall sign and date the **certification mark**. See also B.2.2
- (b) An MNA may appoint one or more persons at a sailmaker's loft to measure and **certify sails** produced by that manufacturer in accordance with the World Sailing In-house Certification Guideline.

#### G.2.3 SAILMAKER

- (a) The choice of the sailmaker is optional. No licence is required.

### G.3 MAINSAIL

#### G.3.1 IDENTIFICATION

- (a) The class insignia shall conform to the dimensions and requirements as detailed in the diagram contained in Appendix H 5.
- (b) The class insignia shall be coloured in a clear contrast colour to the used sailcloth. Dark blue is suggested.
- (c) The class insignia shall be positioned on both sides of the mainsail back to back  $200 \pm 10$  mm below the  $\frac{3}{4}$  draft stripe and  $580 \pm 10$  mm back from the **luff** of the sail. The small dots of the class insignia shall face towards the leech on both sides.

- (d) The national letters and sail numbers shall comply with the RRS. The numbers shall be minimum 300 mm high. For sails built before the 1.1.2011 this specific number size is recommended and not compulsory.
- (e) The national letters shall conform to the requirements detailed in the diagram contained in the Appendix H 3.

### G.3.2 MATERIALS

- (a) The mainsail shall be made of **woven** polyester.
- (b) Weight of **ply** of the **body of the sail** (min.) 200 gr/m<sup>2</sup>.
- (c) Battens: Wood, GRP, FRP. No batten shall be wider than 35 mm.

### G.3.3 CONSTRUCTION

- (a) The construction shall be: **soft sail, single ply sail**.
- (b) The **body of the sail** shall consist of the same **woven ply** throughout.
- (c) The sail shall have 5 batten **pockets** in the **leech**. The upper two shall be full length and extend from **leech** to **luff**.  
The position of the top battens is given in Appendix H.4.1.2  
The other three battens **pockets** shall be no longer than 1350 mm and shall be equally placed on the **leech** between the second full batten and the clew with a tolerance of  $\pm 100$  mm.  
For sails built before the 1.1.2011 this specific batten size and position rule does not apply.
- (d) At least one usable reef position must be fitted. The reef(s) shall be a minimum of 1000 mm and a maximum of 4000 mm above the tack.
- (e) Two windows are permitted one below and one above **half width**.
- (f) The following are permitted: Stitching, glues, webbing, **woven** and PTFE tapes, bolt ropes, corner eyes, corner rings, headboard with fixings, Cunningham eye or pulley, Velcro or other fastenings, reefing points, **batten pocket patches**, batten pocket elastic, **batten pocket** end caps, batten retaining devices, mast and boom slides, leech line with cleat, windows, tell tales, sail shape indicator stripes and items as permitted or prescribed by other applicable rules.
- (g) The leech shall not be convex between the battens, girth measures are taken up to a straight line between batten ends if leech is concave (See ERS).
- (h) The head curve shall not be convex.
- (i) The mainsail shall be loose-footed.

### G.3.4 DIMENSIONS

- (a) Sail reinforcements are not restricted.
- (b) Maximum dimensions are: (see drawing in Appendix H 4.1.1 + H4.1.2)
 

<b>Leech length</b>	10'250 mm
<b>Top width</b>	160 mm
<b>MGT - Upper width (7/8 width)</b>	1'040 mm
<b>MGU - Three quarter width</b>	1'600 mm
<b>MGM - Half width</b>	2'400 mm
<b>MGL - Quarter width</b>	2'960 mm
<b>Batten pocket width</b>	35 mm
<b>Window area</b>	1.0 m <sup>2</sup>

## G.4 JIB

### G.4.1 MATERIALS

- (a) The jib must be made of **woven** polyester.
- (b) Weight of **ply** of the **body of the sail** (min.) 250 gr/m<sup>2</sup>
- (c) Battens: Wood, GRP, FRP.

### G.4.2 CONSTRUCTION

- (a) The construction shall be: **soft sail, single ply sail**.
- (b) The **body of the sail** shall consist of **woven** throughout.
- (c) The jib may have 3 battens in the **leech**. The 3 battens shall be equally placed on the **leech**. The top batten may be a full batten. No **batten pocket** shall be longer than 800 mm.
- (d) Windows are permitted below **half width**.
- (e) The following are permitted: Stitching, glues, webbing, tapes, eyes, corner rings, Velcro or press studs, battens, **batten pockets, batten pocket elastic, batten pocket patches, batten pocket end caps**, leech line with cleat, foot line with cleat, windows, zip for sleeve luff, tell tales, sail shape indicator stripes and items as permitted or prescribed by other applicable rules.
- (f) The following is prohibited: Cunningham eye or pulley, two blocks on the clew of the sail for the jib sheets.

### G.4.3 DIMENSIONS

Maximum dimensions are: (see drawing in Appendix H 4.2)

<b>Luff length</b>	9'640 mm
<b>LP</b> (clew point to luff, jib perpendicular)	2'970 mm
<b>Top width</b>	60 mm
<b>Three quarter width</b>	733 mm
<b>Half width</b>	1'436 mm
Max <b>batten pocket</b> length	800 mm
Max <b>batten pocket</b> width	40 mm
<b>Windows</b> area	0.75 m <sup>2</sup>

## G.5 GENOA

### G.5.1 MATERIALS

- (a) The genoa must be made of **woven** or **laminated polyester**. Aramid (Kevlar) fiber or similar (Carbon, Spectra) are not allowed. Fibers must be layed straight and uniformly parallel.
- (b) Minimum cloth weight shall be 120 gr/m<sup>2</sup> for a sail with woven polyester and 105 gr/m<sup>2</sup> for a sail with **laminated polyester**.
- (c) Battens are prohibited.

### G.5.2 CONSTRUCTION

- (a) The construction shall be: **soft sail, single ply**.
- (b) The **body of the sail** shall consist of **woven** or **laminated ply** throughout.
- (c) **Windows** are permitted below **half width**.

- (d) The following are permitted: Stitching, glues, webbing, tapes, corner eyes, corner rings, Velcro or press studs, leech line with cleat, foot line with cleat, **windows**, zip for sleeve luff, tell tales, sail shape indicator stripes and items as permitted or prescribed by other applicable rules.
- (e) The following is prohibited: Cunningham eye or pulley, two blocks on the clew of the sail for genoa sheets.

### G.5.3 DIMENSIONS

Maximum dimensions are: (see drawing in Appendix H 4.3)

<b>Luff length</b>	9'640 mm
<b>Luff perpendicular</b>	3'900 mm
<b>Top width</b>	60 mm
<b>Windows area</b>	0.75 m <sup>2</sup>

## G.6 MASTHEAD SPINNAKER

### G.6.1 MATERIALS

- (a) The **ply** fibres shall consist of woven nylon or polyester.
- (b) **Sail reinforcement** shall consist of:
  - Primary reinforcement** – material optional
  - Secondary reinforcement** – woven nylon or polyester
- (c) Minimum cloth weight of the body of the sail shall be 36 grams

### G.6.2 CONSTRUCTION

- (a) The construction shall be: **soft sail, single ply sail**.
- (b) The **body of the sail** shall consist of **woven ply** throughout.
- (c) National letters and sail numbers are optional.
- (d) The following are permitted: Stitching, glues, webbing, woven tapes, corner eyes, corner rings, leech lines, foot line, tell tales and items as permitted or prescribed by other applicable rules.

### G.6.3 DIMENSIONS

Maximum dimensions are: (see drawing in Appendix H 4.4)

Leech length (SL)	11'500 mm
Mid width (SMG)	6'700 mm minimum 75% of foot length (SF)
Foot length (SF)	6'500 mm

Weight of ply of the body of the sail (minimum) 36 g/m<sup>2</sup>

## G.7 FRACTIONAL SPINNAKER

### G.7.1 MATERIALS

- (a) The **ply** fibres shall consist of woven nylon or polyester.
- (b) **Sail reinforcement** shall consist of:
  - Primary reinforcement** – material optional
  - Secondary reinforcement** – woven nylon or polyester
- (c) Minimum cloth weight of the body of the sail shall be 40 grams

### G.7.2 CONSTRUCTION

- (a) The construction shall be: **soft sail, single ply sail**.
- (b) The **body of the sail** shall consist of **woven ply** throughout.



- (c) National letters and sail numbers are optional.
- (d) The following are permitted: Stitching, glues, webbing, woven tapes, corner eyes, corner rings, leech lines, foot line, tell tales and items as permitted or prescribed by other applicable rules.

### G.7.3 DIMENSIONS

Maximum dimensions are:	(see drawing in Appendix H 4.4)
Leech length (SL)	10'000 mm
Mid width (SMG)	5'870 mm minimum 75% of foot length (SF)
Foot length (SF)	5'690 mm
Weight of ply of the body of the sail	(minimum) 40 g/m <sup>2</sup>

# PART III – APPENDICES

The rules in Part III are **closed class rules**. Measurement shall be carried out in accordance with the ERS except where varied in this Part.

## Appendix A1 – Keel details

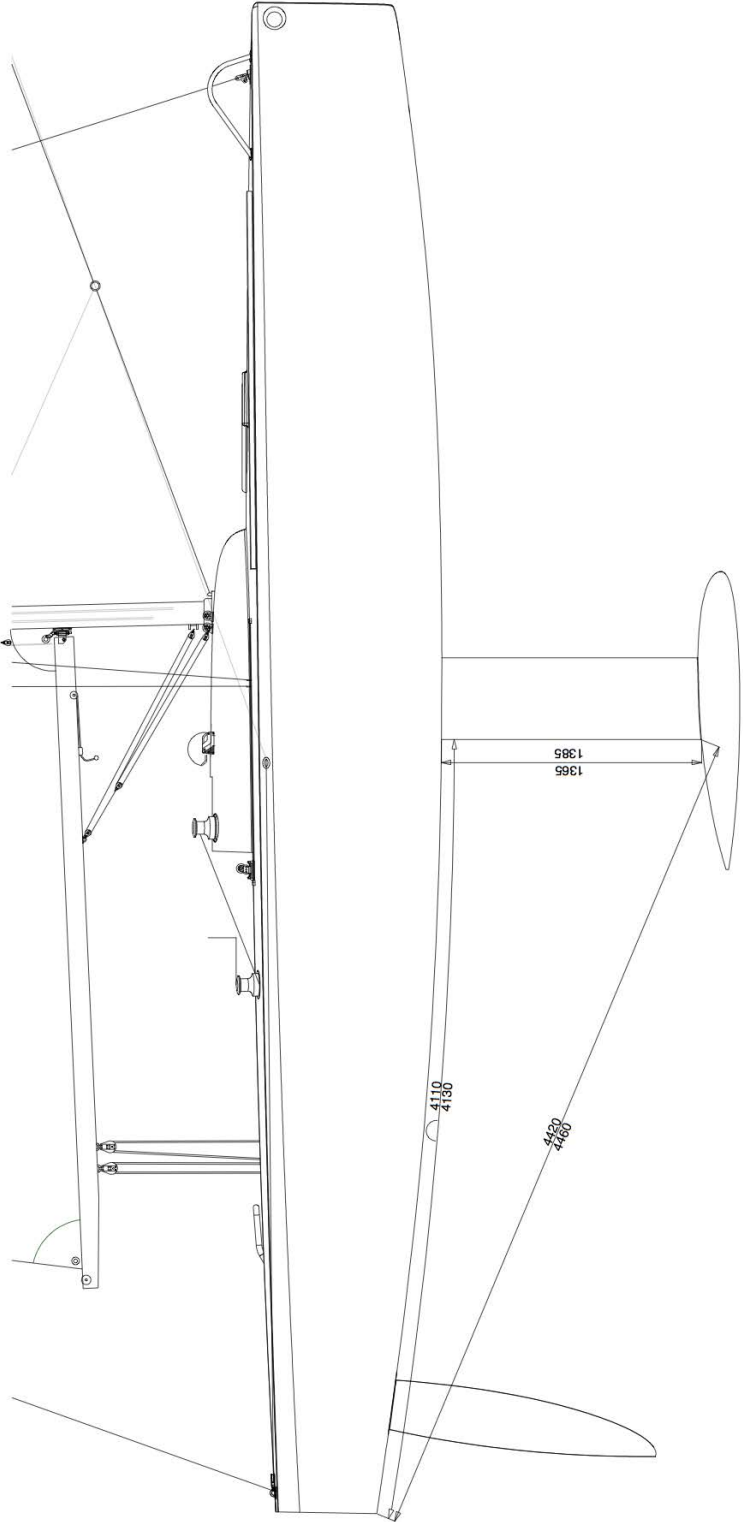

# Appendix A2 – Rudder details

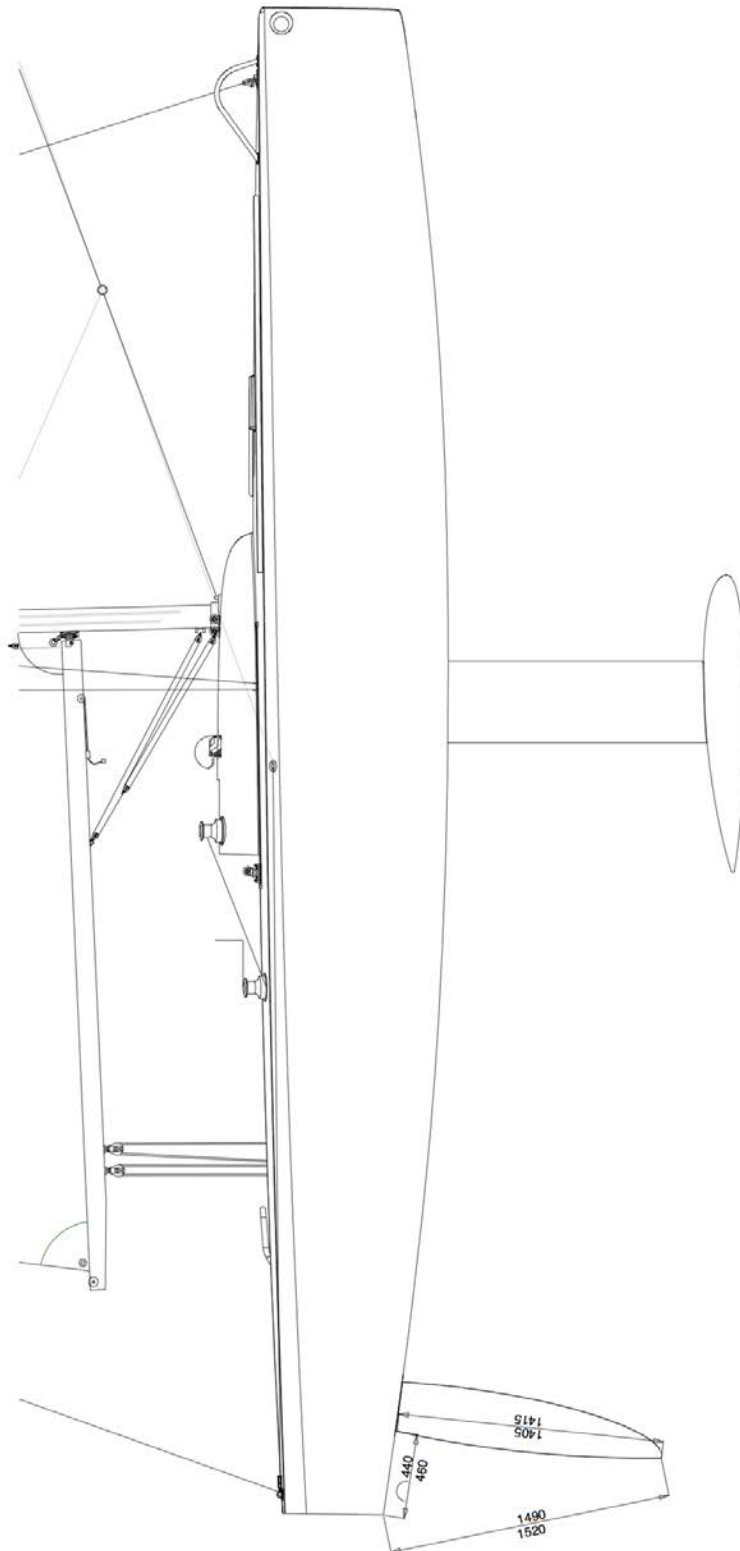

# Appendix A3 – Corrector weights positions

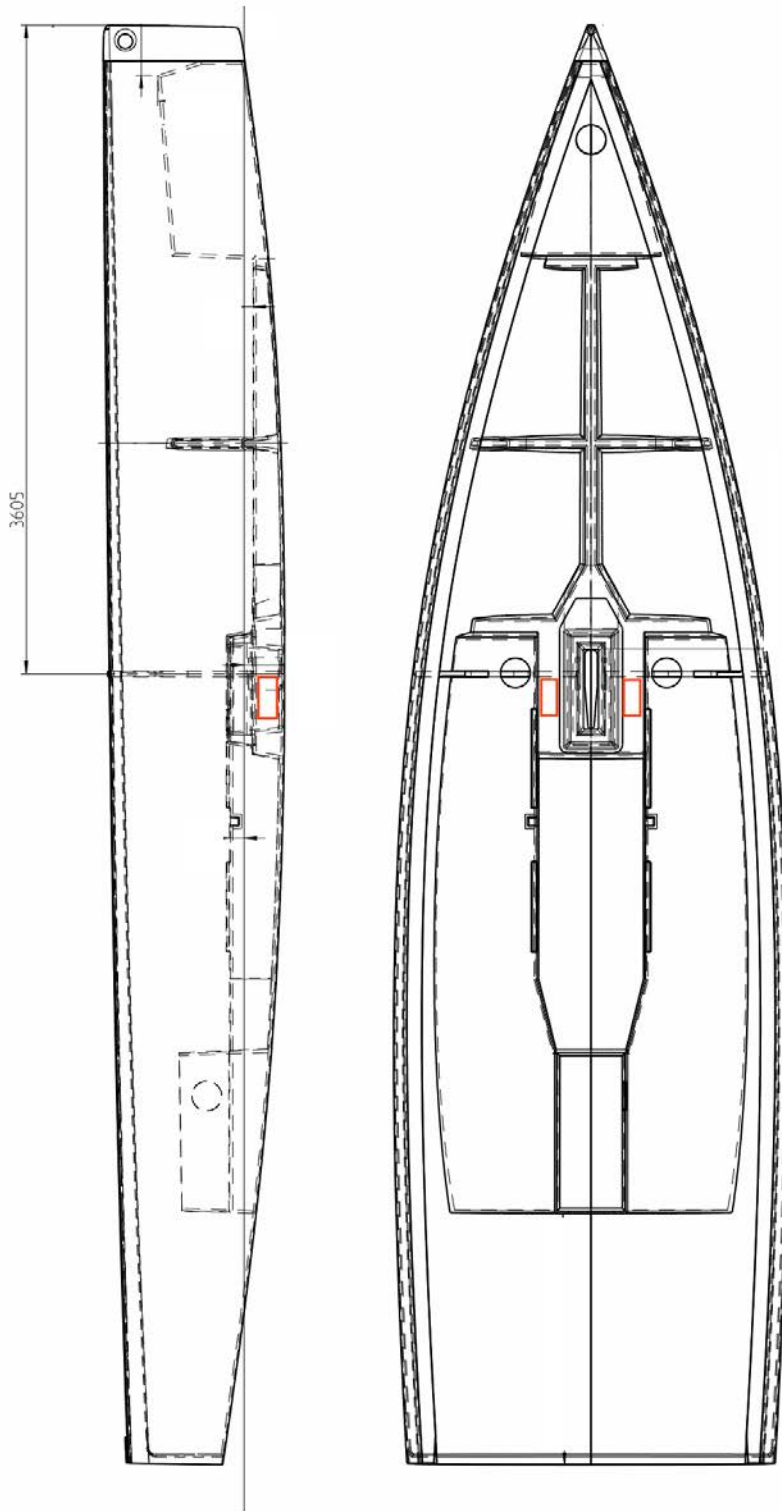

# Appendix F1 – Hardware and fittings

## DECK HARDWARE RONSTAN

---

### Travellersystem

Series 22 track 1.0 m, black	1
Series 22 125mm traveller with 2x2 30mm disks	1
Series 22 end cap incl. 40mm BB single sheave with becket	2
Ronstan 30mm single upright lead	2
Ronstan C-Cleat medium black	2
Ronstan heavy duty fairlaed black	2

### Mainsheet System

Series 55 BB Orbit block triple with looptop	1
Series 55 BB Orbit block, fiddle becket and looptop	1
Series 55 BB Orbit block with looptop	1
Ronstan swivelbase with cleat and spring	1
Series 70 RT Orbit block with looptop or Lewmar Racing Serie 60 ratchet block	1
Dyneema loop 30cm/8mm	2

### Genua System

Series 19 track 3.0 m black	1
Series 19 genoa car with or without pins	2
Series 19 end cap	4
Ronstan C-Cleat medium black	2
Optional: Adjustable genoa car with purchase system	

### Spinnaker System

Series 55 BB Orbit block with looptop	4
Ronstan C-Cleat medium black	2
Ronstan 25mm plastic ball black	2

### Barber System

Series 30 BB Orbit block incl. swivel and shackle	2
Ronstan C-Cleat medium black	2
Ronstan heavy duty fairlaed black	2
Ronstan 25mm plastic ball black	2
Loop-Papaye 10 silver	2
Optional: Thimble replacing Orbit block incl. Swivel and shackle	

### Gennaker System

Hose clamp VA 90-110mm	1
SeaSure block with aluminium disk	1
Series 30 BB Orbit block inkl. swivel and shackle	1
Ronstan C-Cleat medium black	1
Ronstan heavy duty fairlaed black	1
Ronstan 25mm plastic ball black	1
Loop Bush 10mm dia. 25mm long silver anodized	1

### Mast Collar / Roof

Series 55 upright lead	3
Ronstan 50mm block HL with swivel	1
Series 30 BB Orbit block with swivel and shackle	3
Ronstan C-Cleat medium black	4
Ronstan heavy duty fairlaed black	4

**Cunningham**

Series 30 BB Orbit block with swivel and shackle	2
Ronstan S-Hook 6mm	1

**Vang System (single line)**

Series 50 single block	1
Series 30 BB Orbit block, double with looptop	1
Series 30 BB Orbit block with swivel and shackle	1
Series 30 BB Orbit block, double with looptop	1

**Backstay System**

Ronstan 50mm block HL with swivel	1
Series 30 BB Orbit block, double with looptop	1
Series 30 BB Orbit block, tripple with looptop	1
Series 30 BB Orbit block, single with swivel and shackle	3
Series 30 BB Orbit Block, single cheek	4
Ronstan C-Cleat medium black	2
Ronstan heavy duty fairlaed black	2
Optional: System with thimbles replacing 50 mm block HL	

**Various**

Battlestick adjust. 740-1120 mm	1
LEWMAR Winch 16 or HARKEN Radial Winch 20 PT	4
LEWMAR low profile rund hatch size 22 or equivalent product surced by the building licence holder	1
Wichard folding padeye small - 2700kg	2
Wichard U-Bolt 8x80mm black	2
Winchhandles	2
Optinal: Selftailing winches	

**Misc**

Spinlock XAS Powerclutch 4-8mm double	2
WICHARD shackle with swivel	1
WICHARD shackle	1
WICHARD shackle with safety Ref. 81432	2
3M Safety Walk non skid (m)	3.6

**RUNNING RIGGING**

---

Mainhalyard (Dyneema)	1
Spihalyard (Dyneema)	1
Jibhalyard (Dyneema)	1
Toppinglift (Dyneema)	1
Spidownhaul (Dyneema)	1
Spisheet (Dyneema)	2
Jibsheets (Dyneema)	2
Mainsheet (Dyneema)	1
Barberhauler (Dyneema)	2
Reef (Dyneema)	1
Traveller (Dyneema)	1
Vang (Dyneema)	1
Vang strop (Dyneema)	1
Cuningham (Dyneema)	1

Backstay (Dyneema)	1
Backstay strop (Dyneema)	1
Spinnaker pole lines (Dyneema)	4
Trigger line spinnaker pole (Dyneema)	1
Backstay (Dyneema or cable)	1

---

## **MAST**

### **General Mast**

Mast	1
Spreader	4
Boom	1
Spinnaker pole	1
Forestay 5mm (Optional: Furling system)	1
V1 Shroud 5mm	2
D1 Shroud 5mm	2
V2 Shroud 4mm	2
D2 Shroud 4mm	2

### **Masttop**

Sailbatten Bluestreak untapered 1.2 m	1
Stainlesssteel ring 30mm	1
Dyneema-line 3mm	1
Windex 15	1

---

## **RUDDER SYSTEM**

Flange only (!) of Tiller head 47030	1
Set of lower and upper bearing	1
Rudder shaft	1

---

## **KEEL SYSTEM**

Keel fin	1
Keel bulb	1
Rubbersealmat 600x300x6mm	1
Rubbergelue Teroson Terokal	1

---

## **INTERIOR**

### **Cockpit hatch**

Latch look with sliding bolt	2
Latch look front side	1

### **Buoyancy tanks**

Inspection hatches D164MM white	4
---------------------------------	---

# Appendix H1 – Mast details

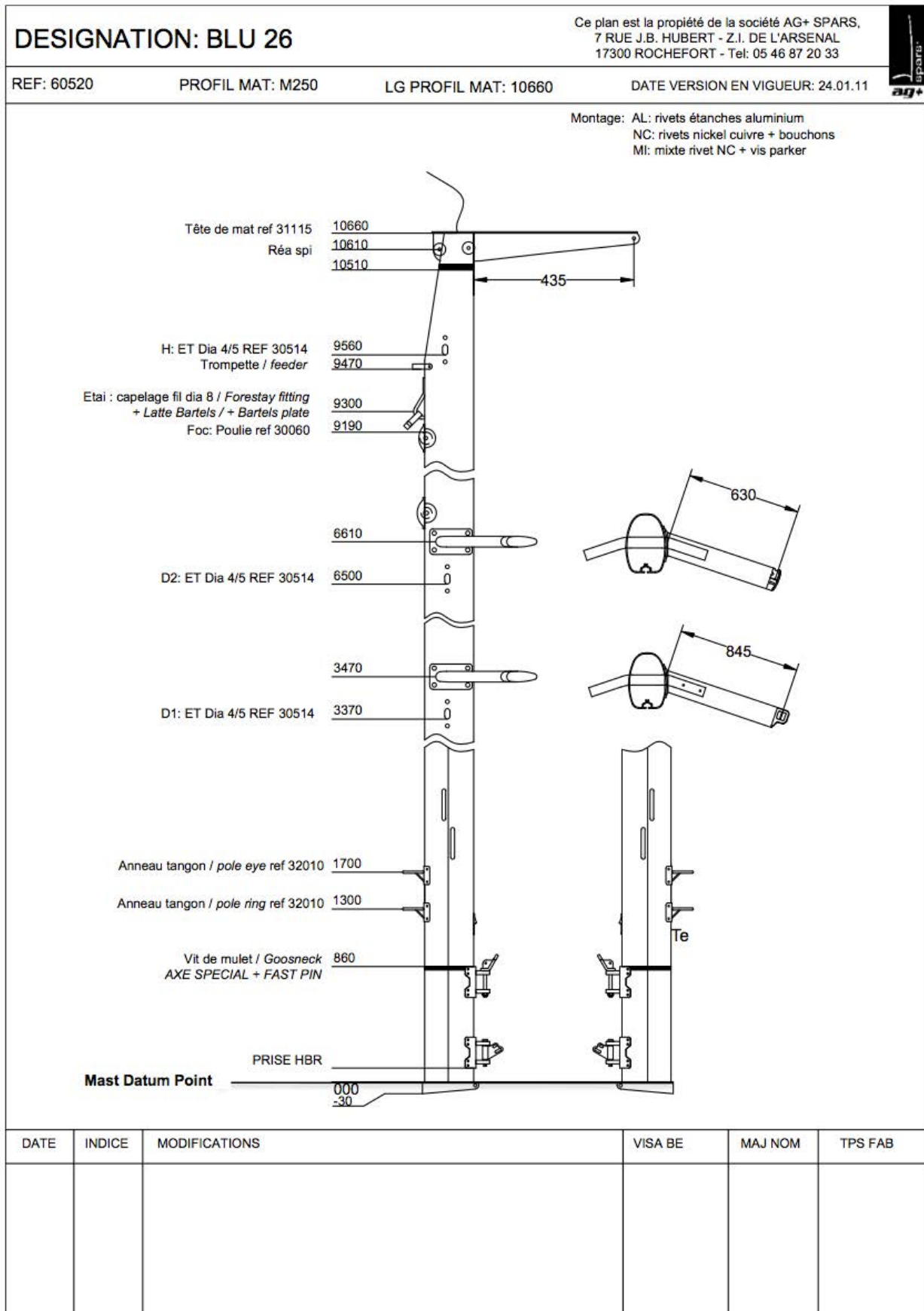



## Appendix H2 – Boom and Spinnaker pole details

DESIGNATION: BLU 26			Ce plan est la propriété de la société AG+ SPARS, 7 RUE J.B. HUBERT - Z.I. DE L'ARSENAL 17300 ROCHEFORT - Tel: 05 46 87 20 33		
BOME REF: 60522 PROFIL BOME: B220 E (Bordure GV):			DATE VERSION EN VIGUEUR: 30.06.11		
DATE	INDICE	MODIFICATIONS	VISA BE	MAJ NOM	TPS FAB
TANGON REF: 60523 DIA TUBE: 57 LG TUBE: 3270			DATE VERSION EN VIGUEUR: 4.02.10		
DATE	INDICE	MODIFICATIONS	VISA BE	MAJ NOM	TPS FAB

## Appendix H3 – Sail numbers and letters

Sail numbers and letters size Minimum 290 mm, Maximum 310 mm  
Sail numbers and letters thickness shall be no more than 65 mm.  
Position of number and letters according to drawing with 10 mm tolerance.

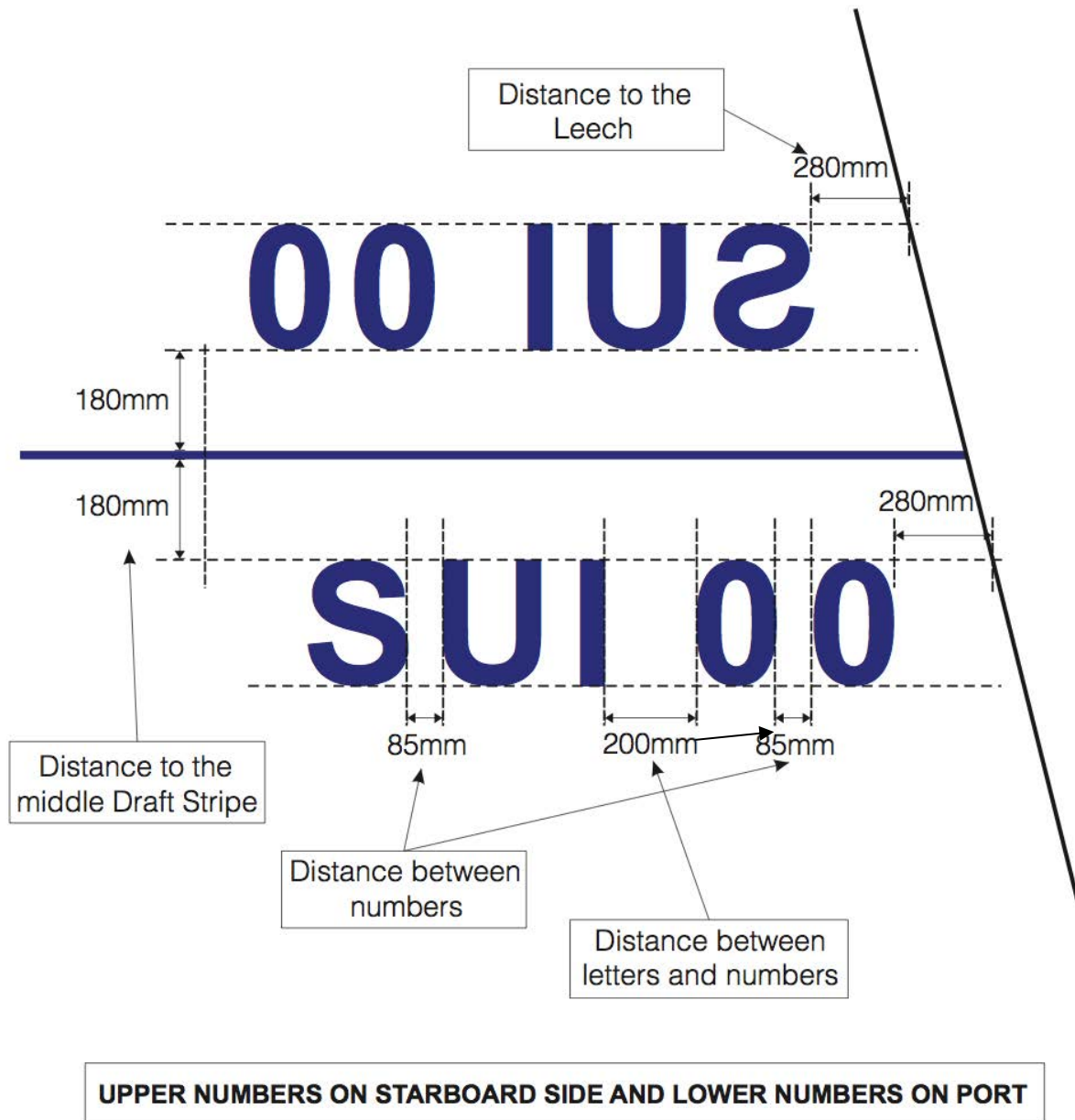

# Appendix H4 – Sails Measurements

## Appendix H4.1.1 Mainsail

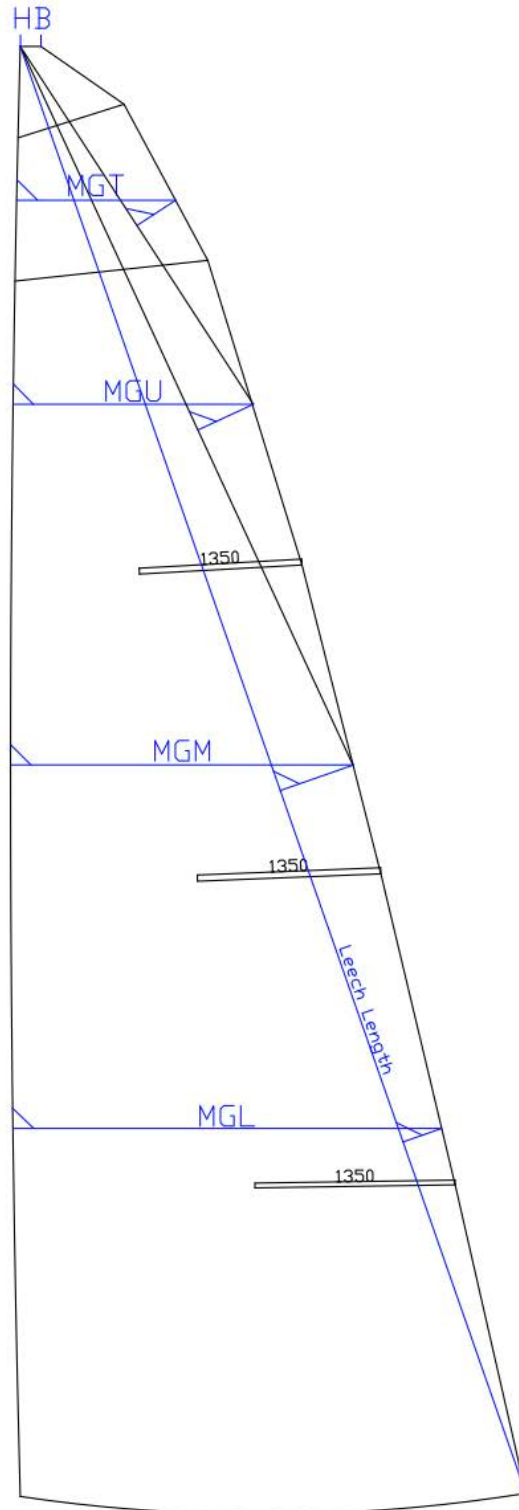

## Appendix H4.1.2 Mainsail - batten limitations

Distances are minima, batten length are maxima

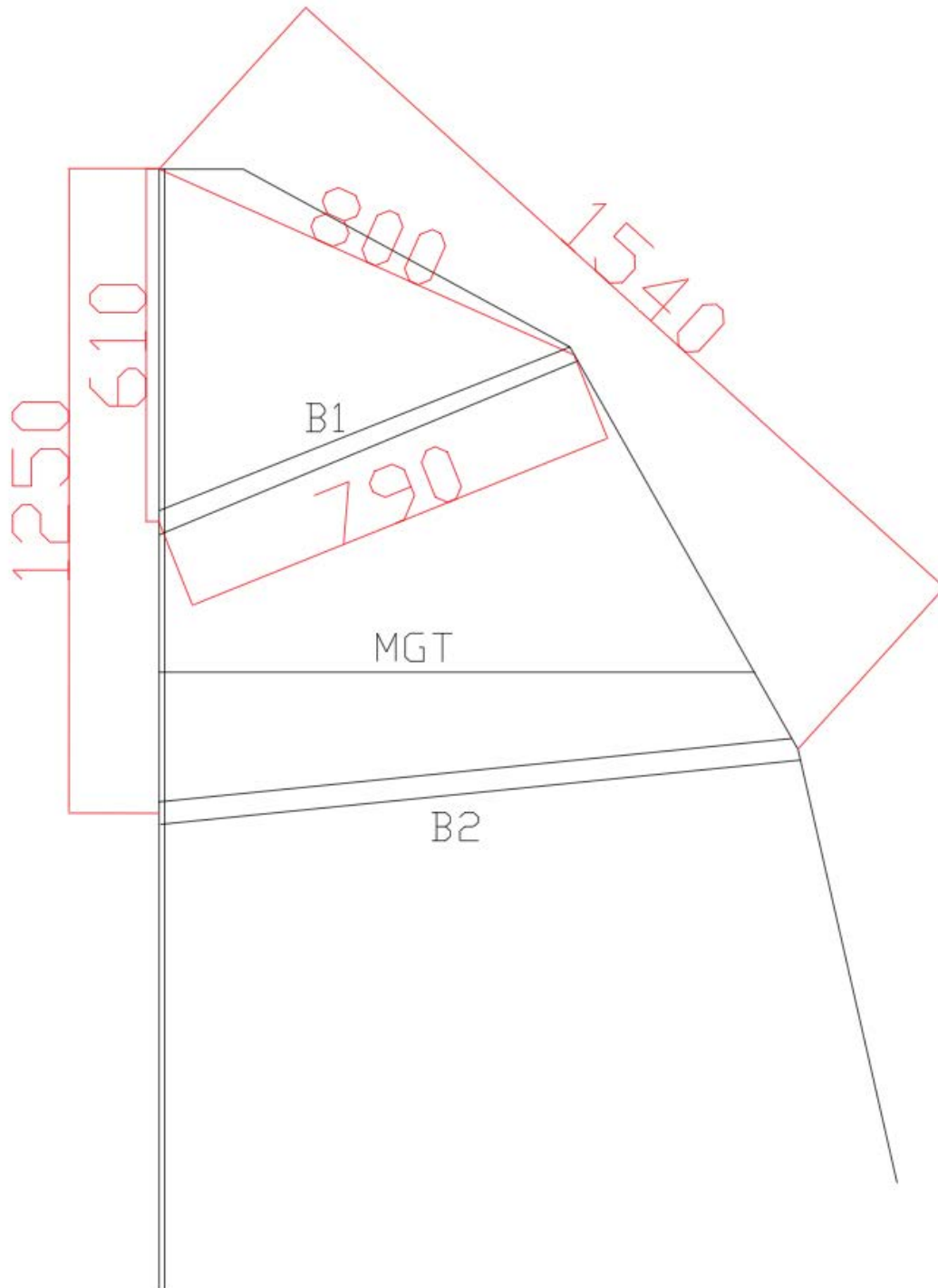

# Appendix H4.2 Jib

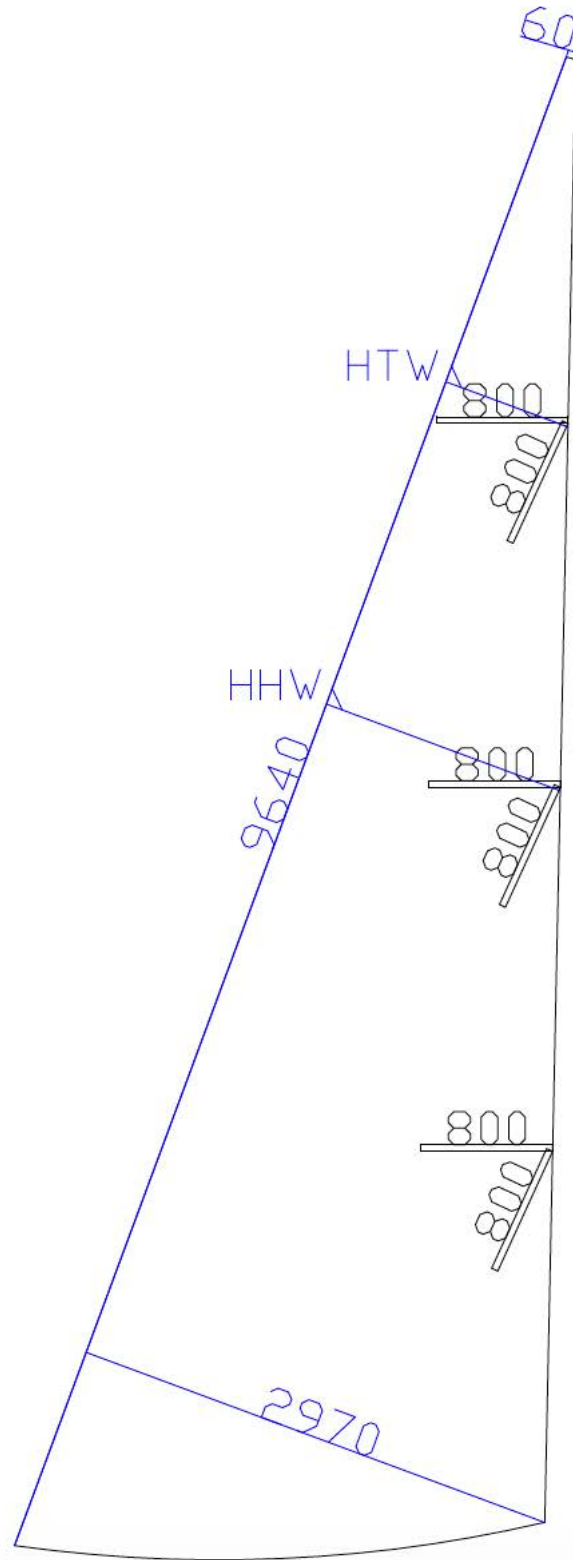

## Appendix H4.3 Genoa

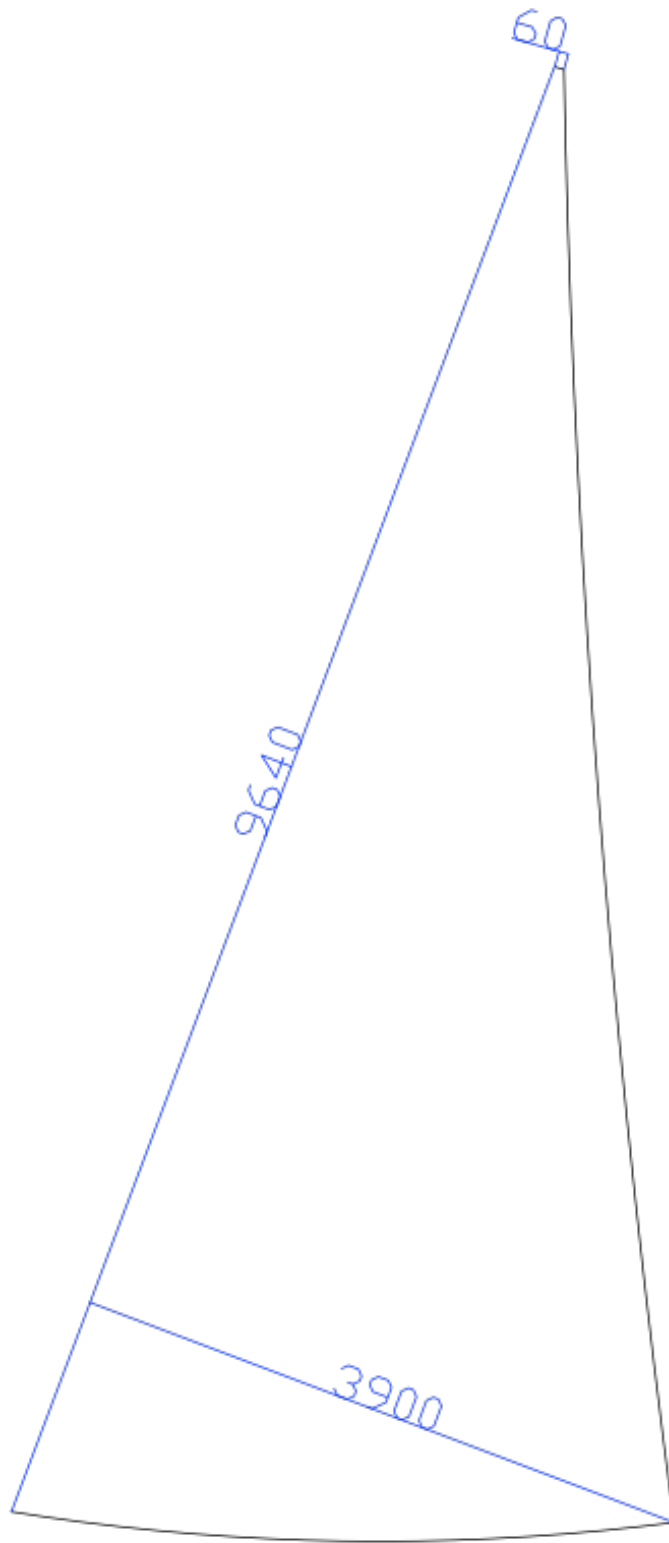

# Appendix H4.4 Spinnaker

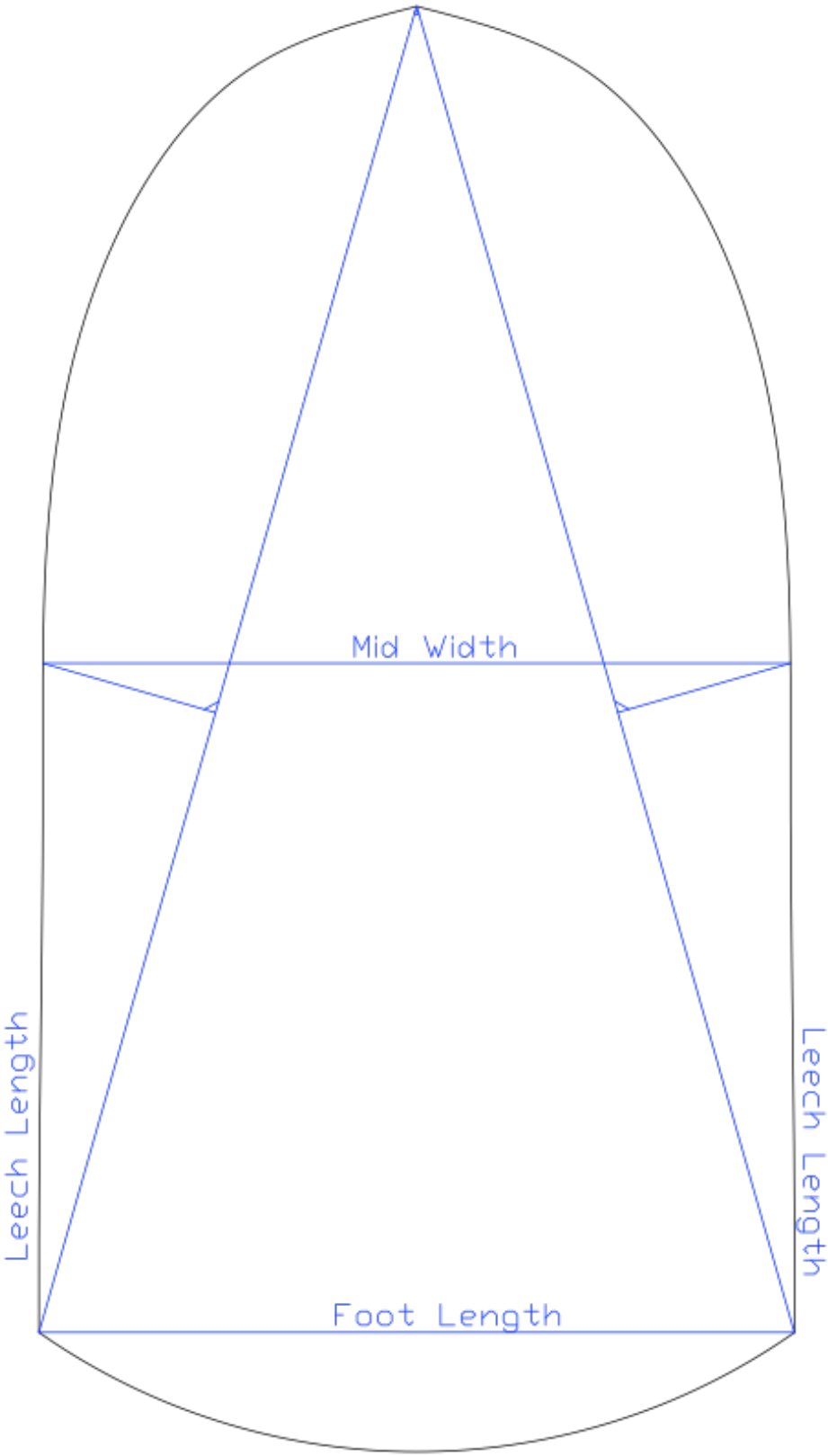

## Appendix H5 – Blu26 Class Insignia and application

Class Logo Diameter 690 mm. Position Class Logo according to drawing.  
All dimensions with a tolerance of 10 mm.

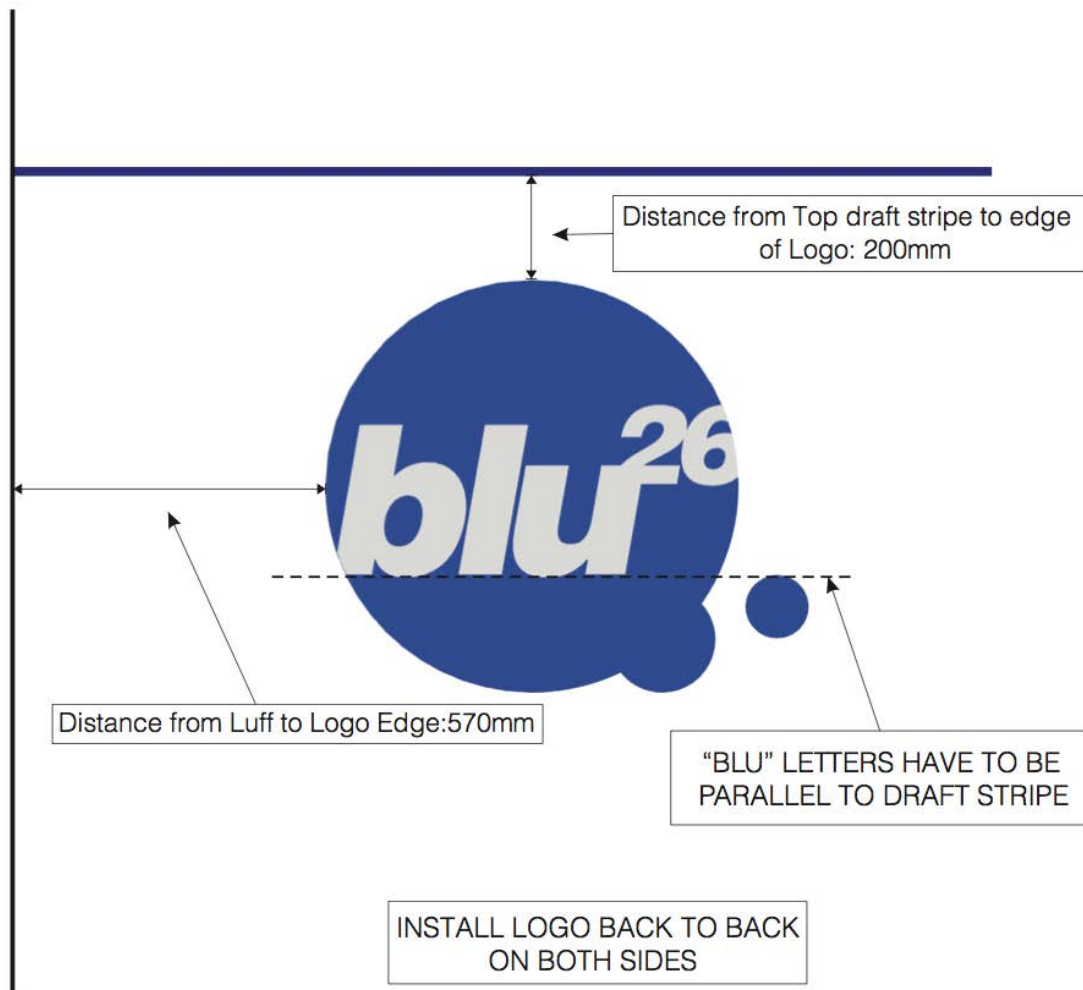



## Appendix H5 – Blu26 Class Insignia application

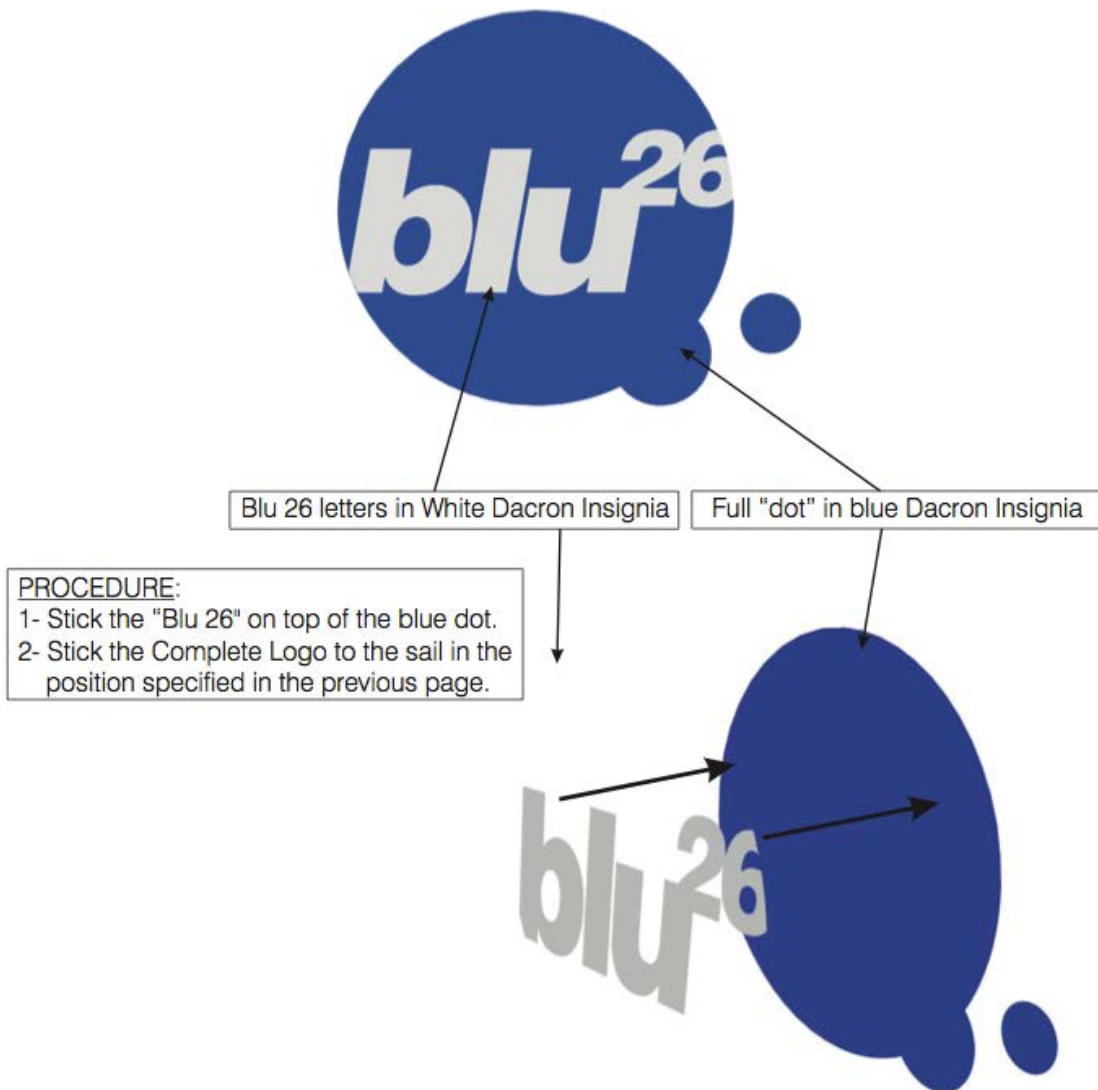

## Appendix H6 – blu26 and bluboats.com Logos

**blu<sup>26</sup>**

**bluboats**

Logo Files are available from Bluboats GmbH / [info@bluboats.com](mailto:info@bluboats.com)

Light blue: Pantone 278 M

Dark blue: Pantone 293 M

### Cabin:



### Cockpit inside:



To be effective after vote on the 23.03.2024 / Circular resolution of the BLU26 International Class Association